

**BION INSTALLATION REQUIREMENTS**

**ADAM BROWN  
ANDREW FAGG**

**801 NW 39 TH STREET  
OKLAHOMA CITY, OK 73118**

**ADAM@ISISCONCEPTUALLABORATORY.COM  
405.602.3127 OR 405.326.8664**



## SUSPENDED CEILING DETAIL AND MATERIALS

### 23 3/4 x 23 3/4 INCH PANEL WITH 25 1/2" DRILLED HOLES

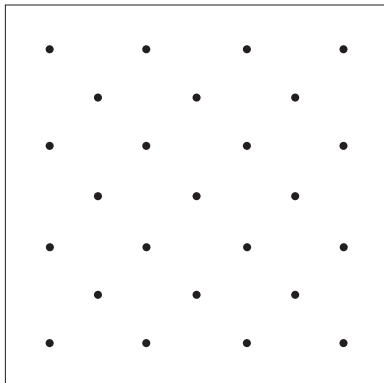

#### EXPANDED PVC SHEETING

EACH 23 3/4 x 23 3/4 INCH PANEL = (MIN) 8.7 LBS  
EACH 23 3/4 x 23 3/4 INCH PANEL WITH SUSPENDED  
ROBOTS = (MAX) 15 LBS

1/2" DRILLED HOLES

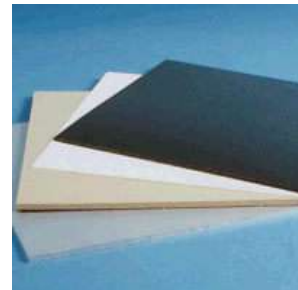

EXPANDED PVC SAMPLE

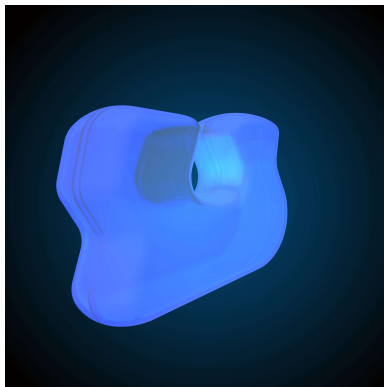

SCALE: 1/8" = 1"

BION

EACH ROBOT (BION)  
DIMENSION: 4x3x1.75"  
WEIGHT: 0.146 LBS (2.34 OZ)

THIS PVC SHEET IS A MODERATELY EXPANDED HIGH DENSITY, POLYVINYL CHLORIDE (PVC) SHEET. AS A LIGHTWEIGHT PLASTIC MATERIAL, IT CAN BE EASILY CUT, SAWED, DRILLED, AND FABRICATED. THE SHEET IS AN EXCELLENT MATERIAL FOR MODEL EXHIBITS AND DISPLAYS. FOR INTERIOR SIGNAGE ONLY. CAN BE PAINTED AND SILK-SCREENED. ITS CHARACTERISTICS INCLUDE: FOAMED PVC SHEET MATERIAL THAT IS APPROX HALF THE WEIGHT OF SOLID PVC; DURABLE AND HARD WEARING UNDER MANY ADVERSE CONDITIONS AND RESISTS MOST CHEMICALS AND WATER, WITH ITS POROUS INTERIOR AND HARD SMOOTH SURFACE; IT CAN BE PAINTED, PRINTED, SILK-SCREENED, LAMINATED, ETC; EASY TO CLEAN AND HAS AN ATTRACTIVE SURFACE, AND IS FIRE RETARDANT. GOOD SOUND DAMPENING-UL 94 FLAMMABILITY CLASS 94 V-O-945; USDA APPROVED. THERE ARE MANY APPLICATIONS FOR THIS VERSATILE, DURABLE MATERIAL

#### ELECTRICAL REQUIREMENTS:

STANDARD 110V AC ON 30 AMP FUSE  
(PREFERABLY LOCATED ON CEILING)

**SUSPENDED CEILING GRID**  
**6X6 FT**

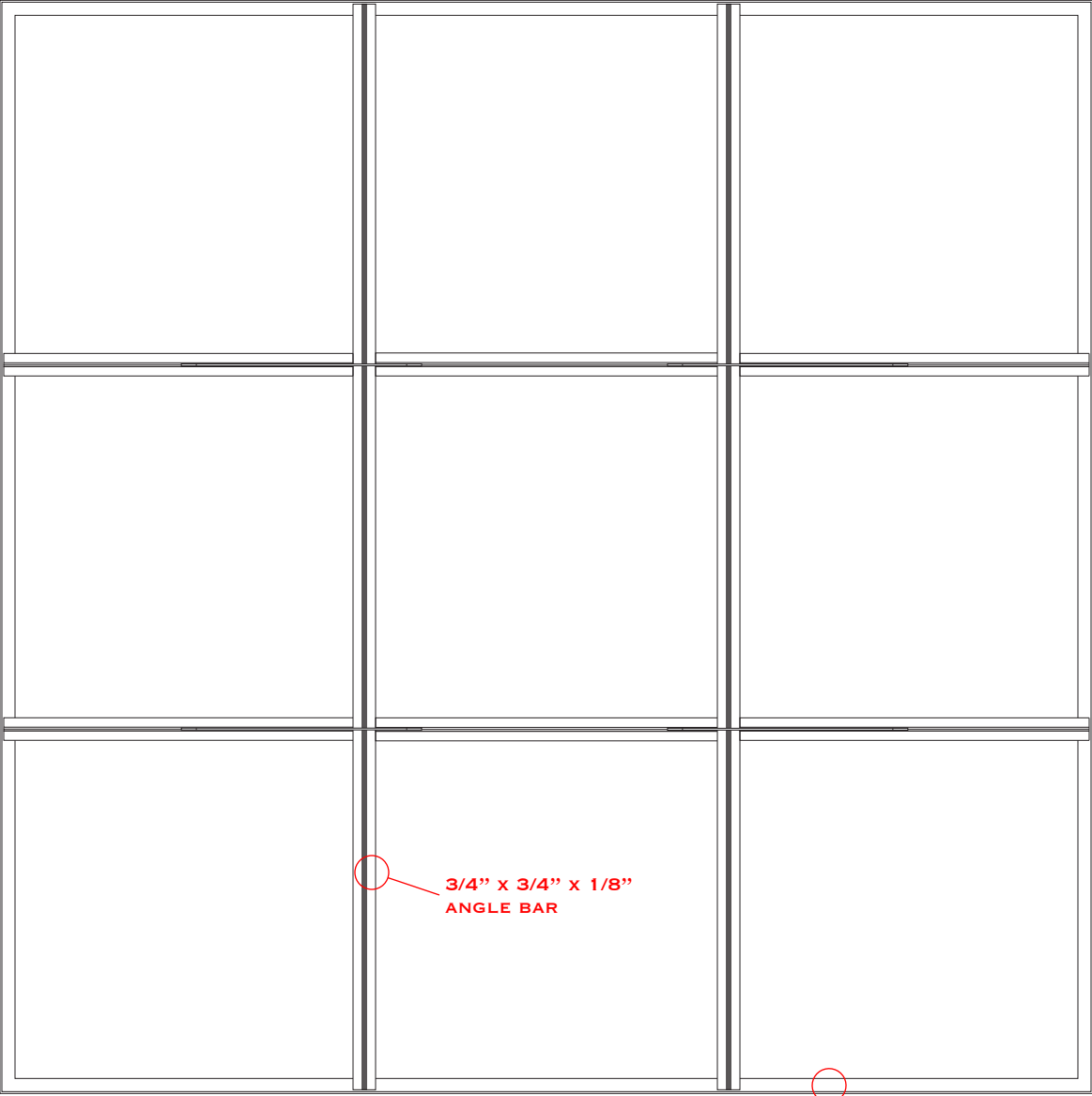

**BACK**

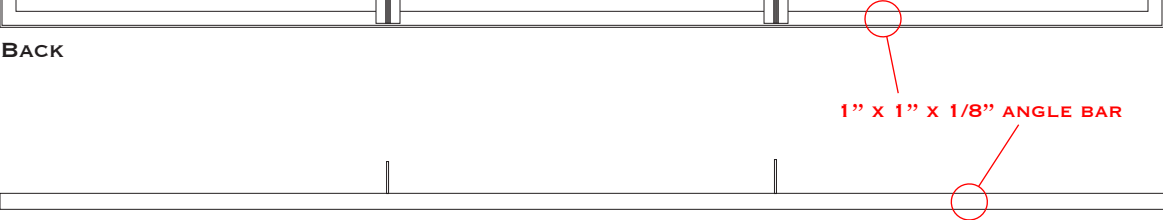

**SIDE**



**FRONT**

SUSPENSION POINTS  
1/2" DRILLED HOLE

**SUSPENDED CEILING GRID**  
**6X6 FT**

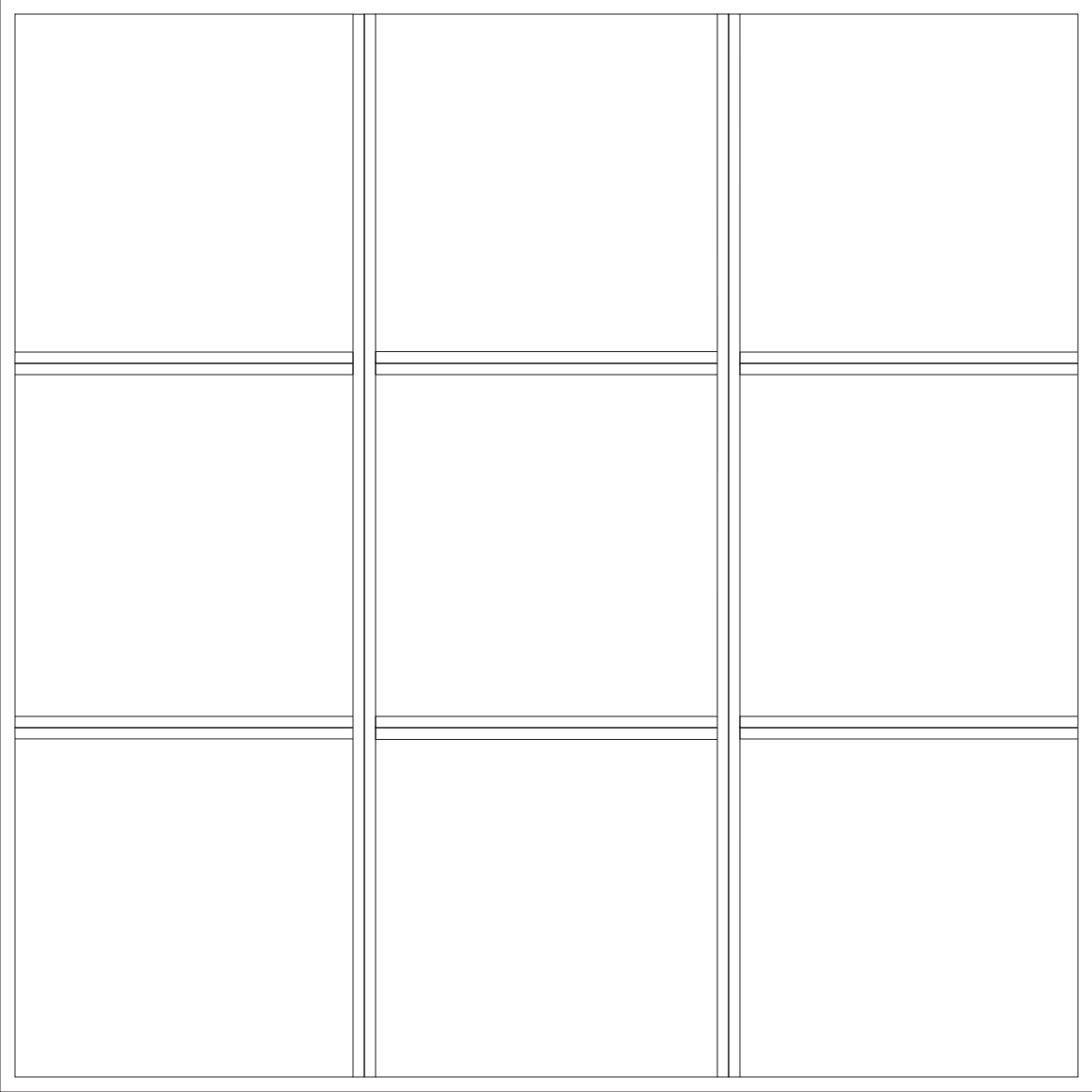

TOP

**SUSPENDED CEILING GRID PERSPECTIVE  
RIGGING DETAIL**

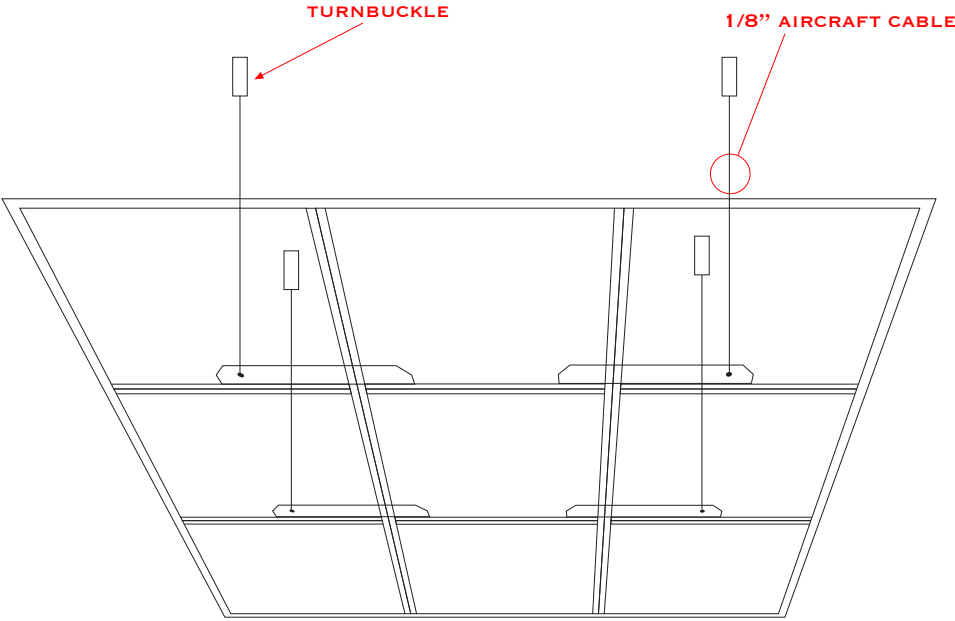

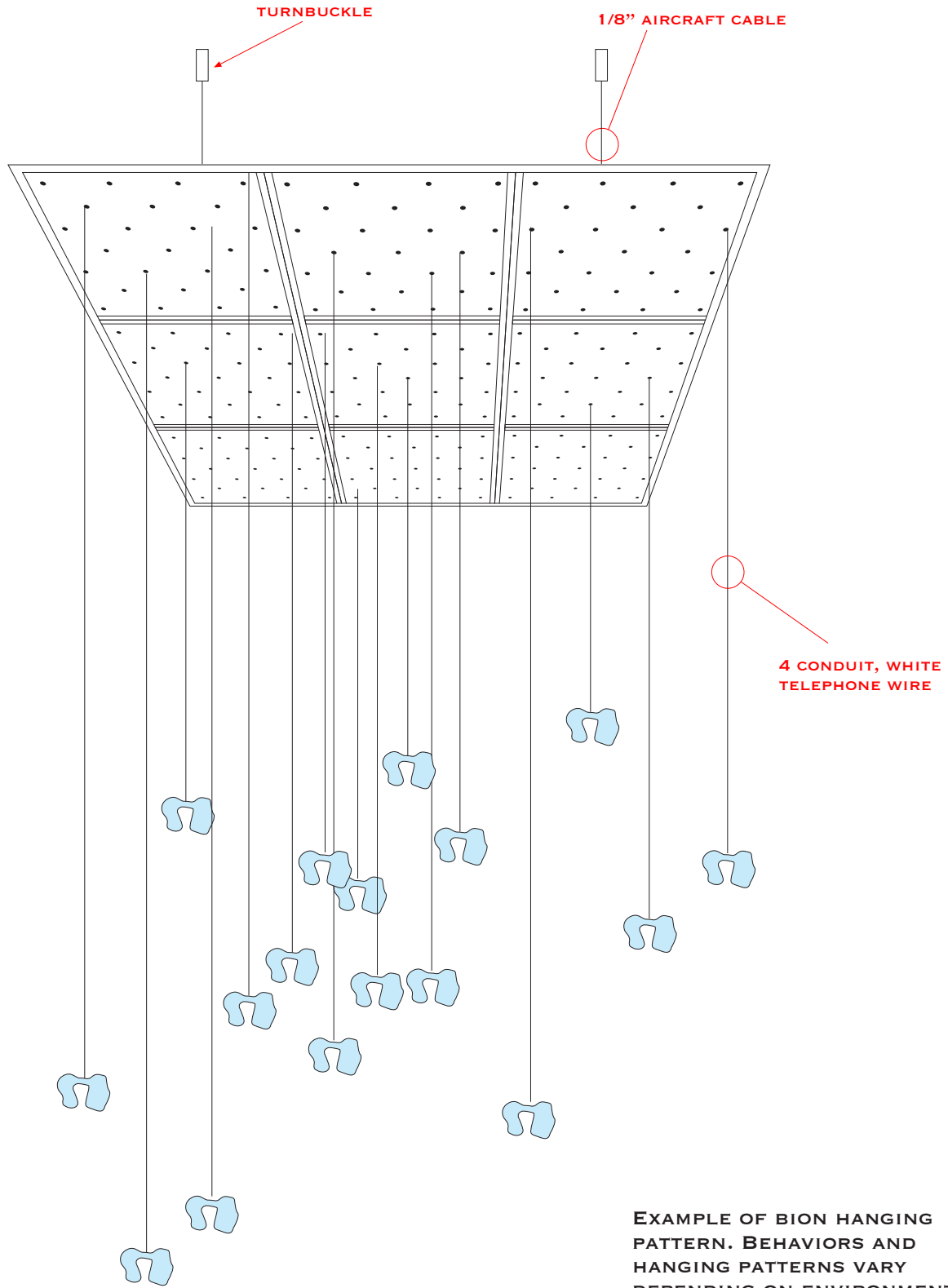

**POSSIBLE SUSPENDED CEILING STRUCTURE  
SEVEN 6X6 FT GRIDS**

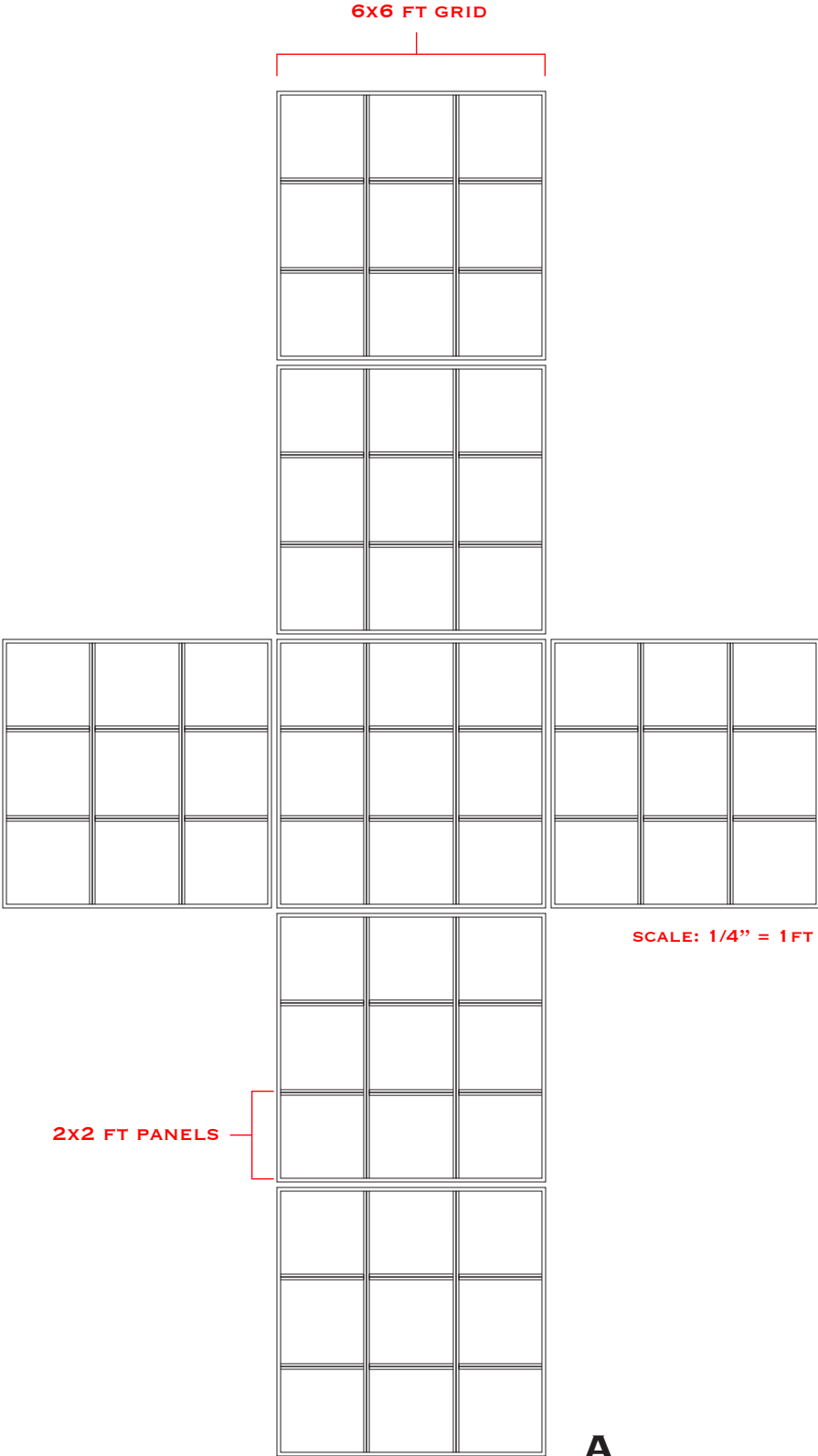

**POSSIBLE SUSPENDED CEILING STRUCTURES  
SEVEN 6X6 FT GRIDS**

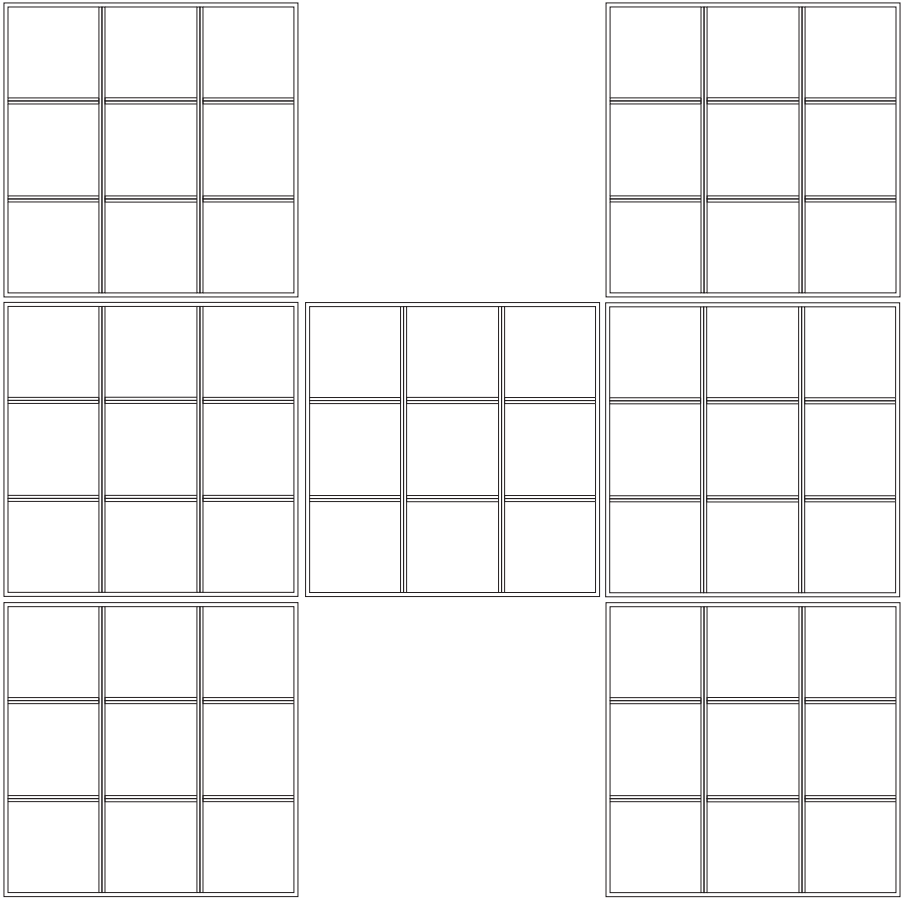

**B**

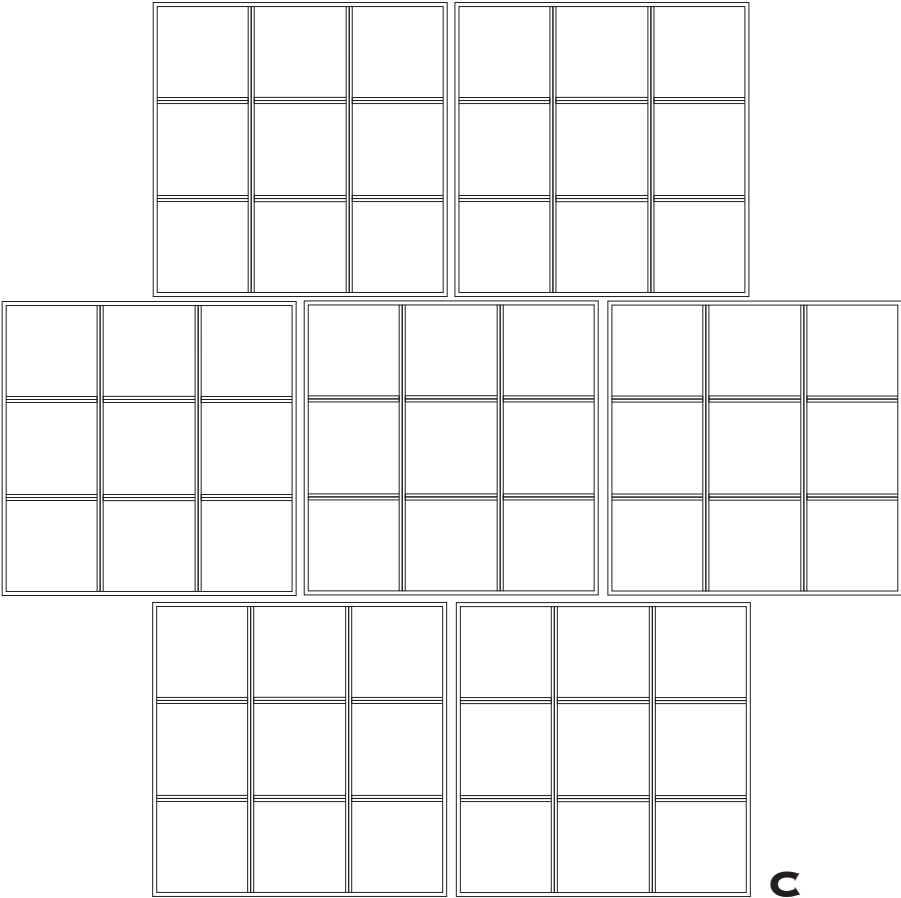

**C**

**SUSPENDED CEILING GRID PERSPECTIVE  
GROUP**

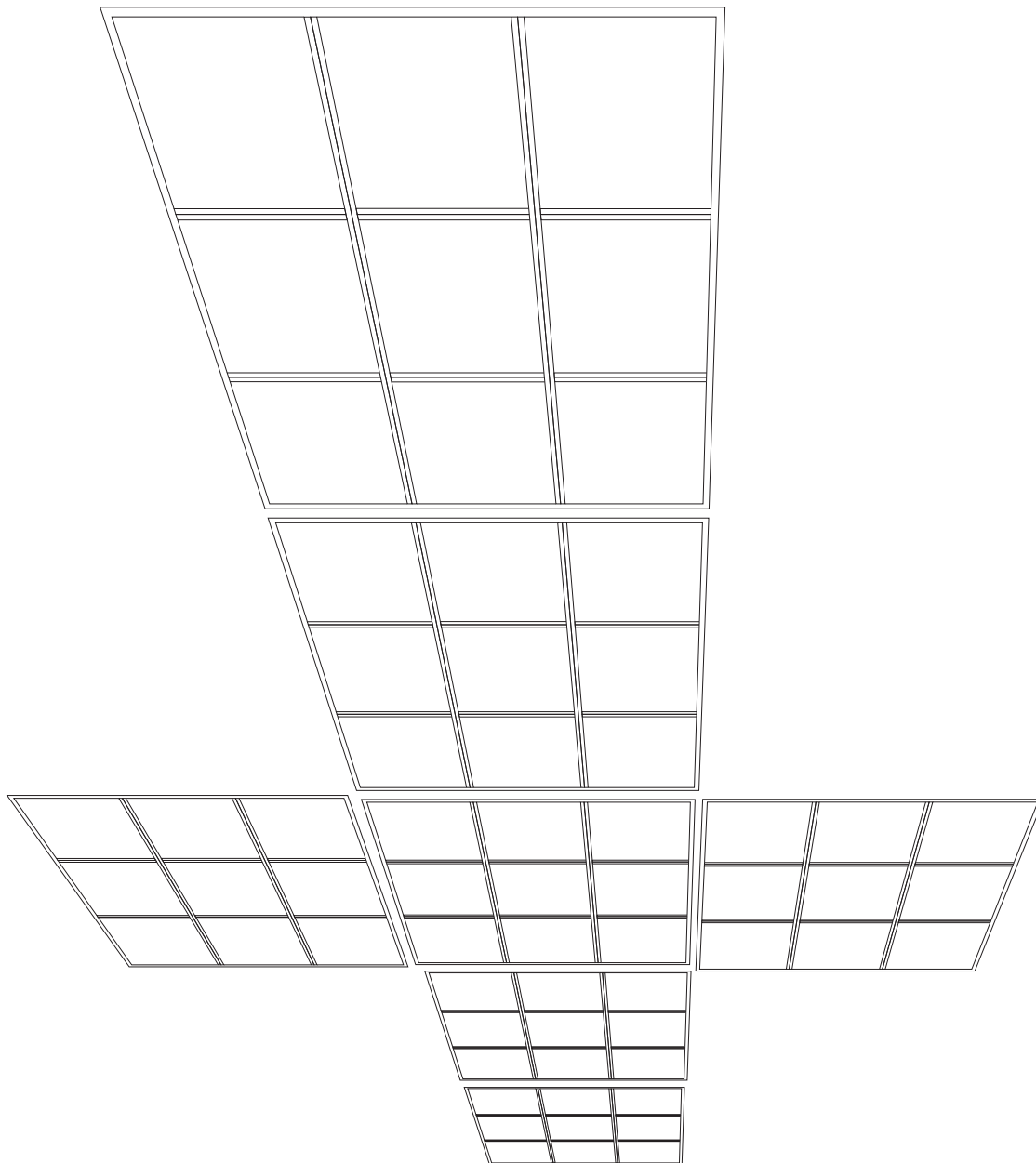

# HOLE PATTERN

23 3/4 x 23 3/4 PANEL  
3/4" EXPANDED PVC SHEET

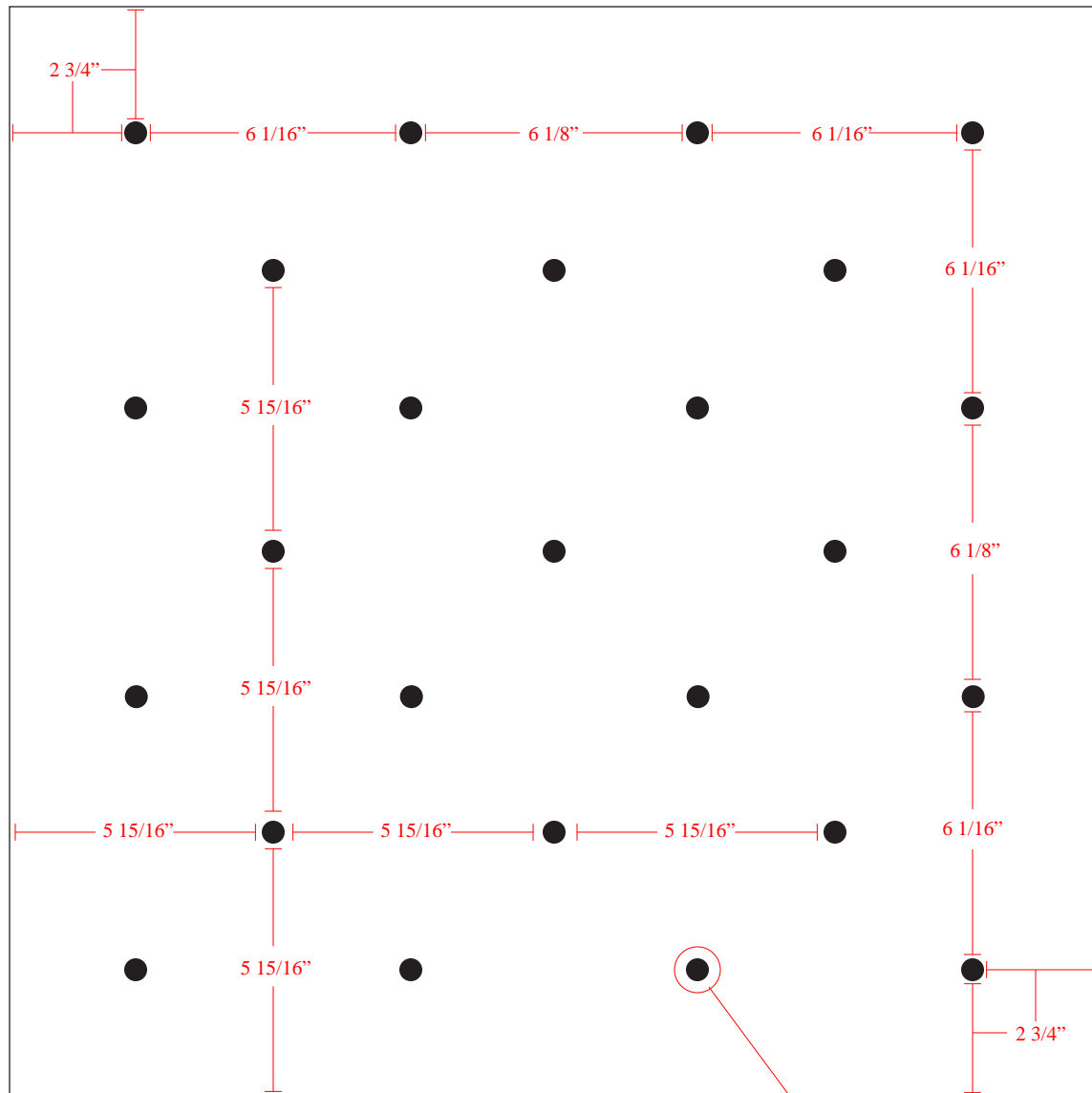

SCALE: 1/4" = 1"

CENTER 11 7/8"

1/2" DRILLED HOLE